

**PARTS LIST:**

Qty	Description	Qty	Description
1	Grille Guard	1	10mm Lock Washer
1	Driver/Left Frame Mounting Bracket	2	8-1.25mm Nut Plates ( <b>06-08 models only</b> )
1	Passenger/Right Frame Mounting Bracket	2	8-1.25mm Clip Nuts ( <b>09-10 models only</b> )
2	Tall Top Support Brackets ( <b>06-08 models only</b> )	2	8-1.25mm x 25mm Button Head Bolts
2	Short Top Support Brackets ( <b>09-10 models only</b> )	2	8mm x 16mm OD x 1.6mm Flat Washers
4	12-1.25mm x 35mm Fine Thread Hex Bolts	2	8mm Lock Washers
1	10-1.25mm x 35mm Fine Thread Hex Bolt (required for 09-10 passenger side Mounting Bracket only)	1	5mm Wrench For Button Head Bolts
6	12-1.75mm x 30mm Hex Bolts	2	6-1.0mm x 25mm Button Head Bolts
16	12mm x 24mm OD x 2.5mm Flat Washers	2	6mm x 12mm OD x 1.6mm Flat Washers
4	12mm Lock Washers	2	6mm Lock Washers
6	12mm Nylon Lock Nuts	1	4mm Wrench For Button Head Bolts
1	10mm x 27mm OD x 3mm Flat Washer		

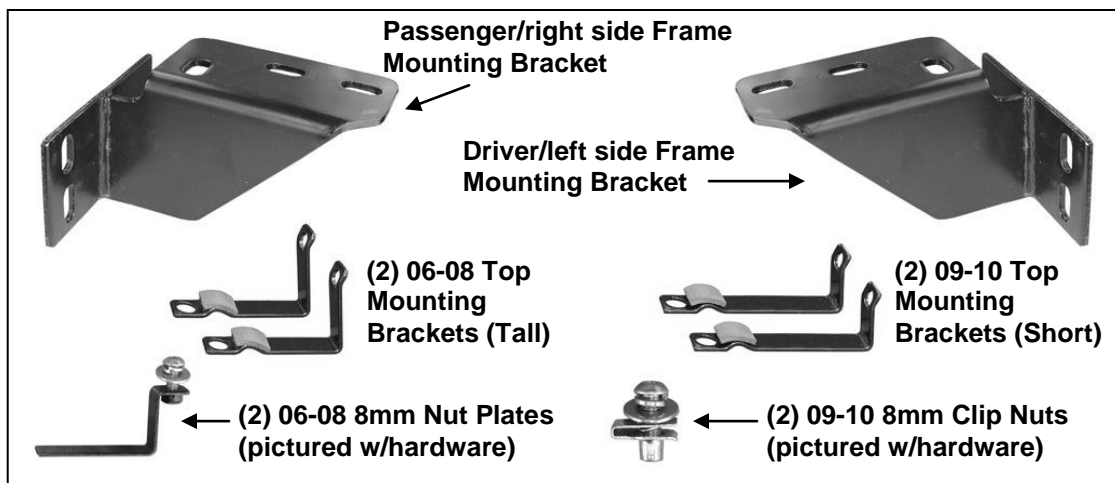

**PROCEDURE:**

- REMOVE CONTENTS FROM BOX. VERIFY ALL PARTS ARE PRESENT. READ INSTRUCTIONS CAREFULLY. ASSISTANCE IS RECOMMENDED. CUTTING IS REQUIRED.**
- Begin the installation by carefully removing the plastic splash guard under the front bumper, (**Figure 3**). **NOTE:** There may be several two-piece plastic push-in clips holding the splash guard up to the vehicle. Pry the center pin up with a small flat blade screwdriver to release and remove the entire clip. Pay close attention to the type and location of all factory hardware for easier reinstallation. Once all clips have been removed, place the splash guard on a clean and stable work surface.
- Locate and remove the two 12mm factory bolts securing the factory driver side frame bracket to the front cross member, (**Figure 1**). Also remove the 12mm hex bolt in the crossmember. Gently pull down on the frame bracket just enough to slide the driver side Mounting Bracket between the frame bracket and the crossmember. **NOTE:** Do not pull too hard or you may bend the frame bracket. If more room is required to insert the Mounting Bracket, loosen but **DO NOT REMOVE** the large hex bolt securing the frame bracket to the subframe mount, (**Figure 1**). Align the holes in the Mounting Bracket with the holes in the frame bracket and reinstall the (3) factory 12mm hex bolts. **IMPORTANT:** On some model years, the factory 12mm hex bolts in the frame bracket are too short to be reused for the Mounting Brackets. (4) 12-1.25mm x 35mm **Fine Thread Hex Bolts**, (4) 12mm Lock Washers and (4) 12mm Flat Washers have been provided to install the driver and passenger side Brackets. Do not tighten hardware.
- Repeat **Step 3** for the passenger side Mounting Bracket installation, (**Figure 2**). **IMPORTANT:** On **09-10** models, replace the (1) factory 10mm hex bolt in the **passenger** side of the crossmember with the

provided longer (1) 10-1.25mm x 35mm **Fine Thread Hex Bolt**, (1) 10mm Lock Washer and (1) 10mm Flat Washer, **(Figure 2)**. Do not tighten hardware at this time.

- Once both Mounting Brackets are in place, hold the splash guard up in position and mark the location of the Mounting Brackets onto the inside surface of the splash guard. Cut only the material required to clear the Mounting Brackets, **(Figure 3)**. Make several cuts and leave as much plastic material as possible. Once trimmed, reinstall the splash guard using the factory hardware.
- Next, open the hood and remove the plastic cover on top of the radiator and grille. Select the appropriate Top Support Brackets for model year, **(See Page 1 for illustration)**.

**06-08 Models:** Select (1) 8mm Nut Plate, **(Figure 4B)**. Insert the Nut Plate through the opening behind the grille on the driver side and line up the threaded hole with the hole in the metal tab and grille. Attach the **Tall Top Mounting Bracket** to the Nut Plate with (1) 8mm x 25mm Button Head Bolt, (1) 8mm Lock Washer and (1) 8mm Flat Washer, **(Figure 5)**. Snug but do not tighten hardware at this time. Repeat this step for passenger side Top Bracket installation.

**09-10 Models:** Gently pull the plastic grille forward to access the metal tab on the driver side of the crossmember. Select (1) 8mm Clip Nut and slide it onto the metal tab with the threaded hole below the metal tab, **(Figure 4A)**. Line up the center of the Clip Nut with the hole in the metal tab and move the grille back into position. Attach the **Short Top Bracket** to the Clip Nut with (1) 8mm x 25mm Button Head Bolt, (1) 8mm Lock Washer and (1) 8mm Flat Washer, **(Figure 5)**. Snug but do not tighten hardware at this time. Repeat this step for passenger side Top Bracket installation.

- With assistance, mount the Grille Guard to the outside of the Mounting Brackets. Use the included (6) 12-1.75mm x 30mm Hex Bolts, (12) 12mm Flat Washers and (6) 12mm Nylon Lock Nuts to attach the Grille Guard to both mounting brackets, **(Figure 6)**. Snug but do not tighten hardware at this time.
- Attach the Top Support Brackets to the Grille Guard with the included (2) 6-1.0mm x 25mm Button Head Bolts, (2) 6mm Flat Washers and (2) 6mm Lock Washers, **(Figure 7)**. Snug but do not tighten hardware.
- Once the Grille Guard is fully mounted onto the vehicle, level, adjust and tighten all hardware.  
**IMPORTANT:** Tighten the large factory hex bolts securing the frame brackets to the subframe mounts loosened in **Step 3**.
- Reinstall the plastic cover on the radiator using the factory hardware with the exception of the (2) clips removed for previously installed Clip Nuts.
- Do periodic inspections to the installation to make sure that all hardware is secure and tight.

**To protect your investment**, wax this product after installing. Regular waxing is recommended to add a protective layer over the finish. Do not use any type of polish or wax that may contain abrasives that could damage the finish.

**For stainless steel:** Aluminum polish may be used to polish small scratches and scuffs on the finish. Mild soap may be used also to clean the Grille Guard.

**For gloss black finishes:** Mild soap may be used to clean the Grille Guard.

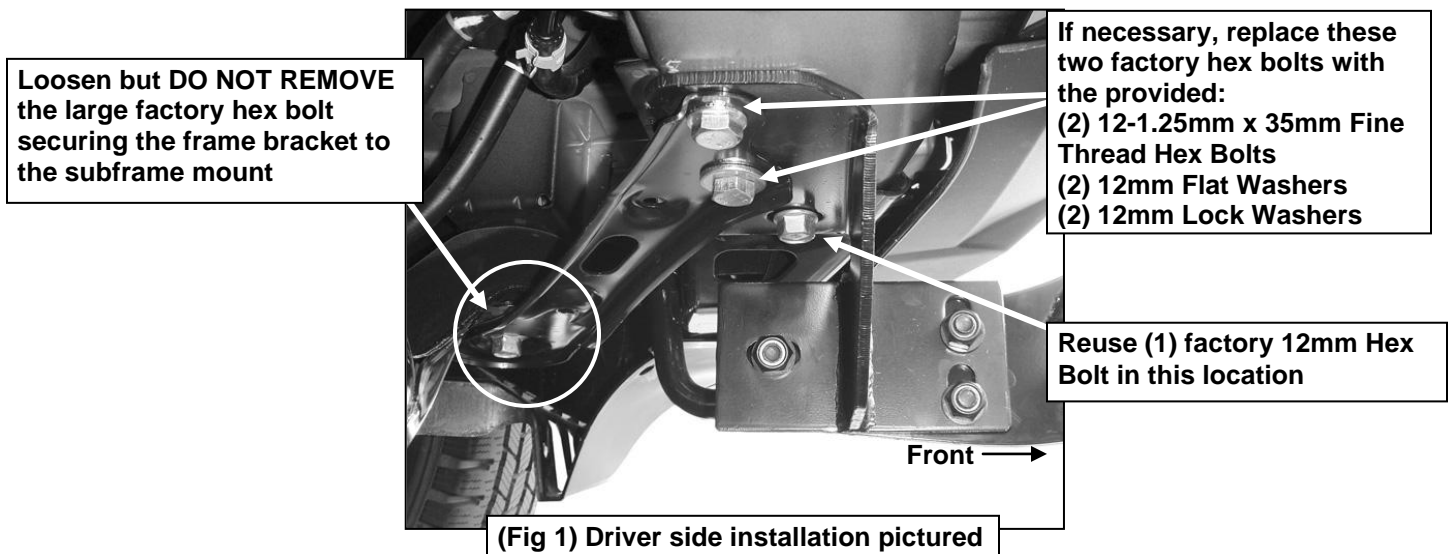

If necessary, replace the factory 10mm Hex Bolt (too short) with the included:  
(1) 10-1.25 x 35mm Fine Thread Hex Bolt  
(1) 10mm Flat Washer  
(1) 10mm Lock Washer

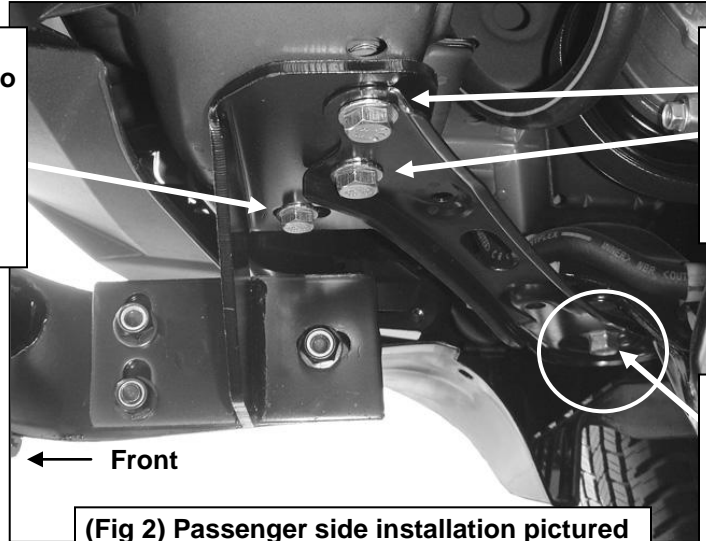

If necessary, replace these two with the provided:  
(2) 12-1.25mm x 35mm Fine Thread Hex Bolts  
(2) 12mm Flat Washers  
(2) 12mm Lock Washers

Loosen but DO NOT REMOVE the large factory hex bolt securing the frame bracket to the subframe mount

(Fig 2) Passenger side installation pictured

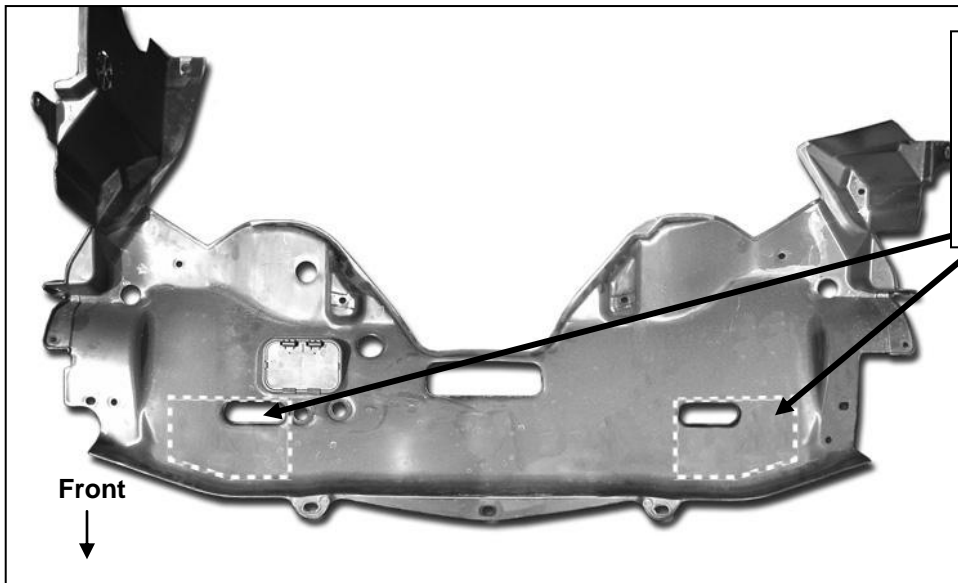

(Fig 3) Area marked on splash guard for example only. Depending on model year, your actual splash guard and cut out area may be different (09-10 model pictured)

Front  
↓

06-08 models use 8mm Nut Plate

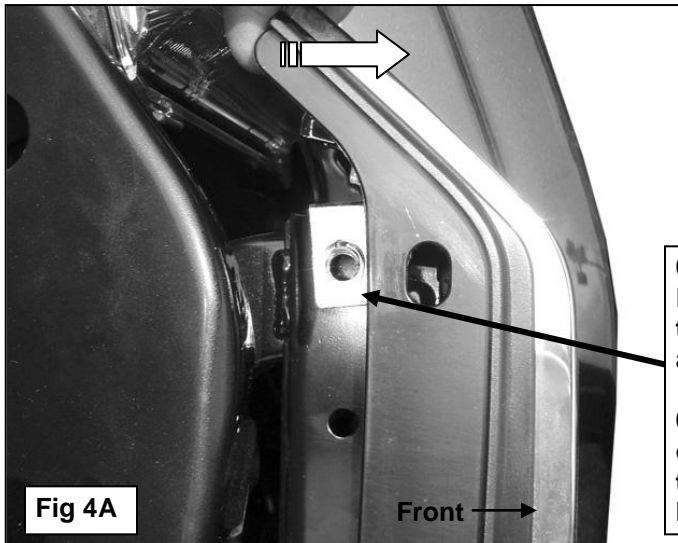
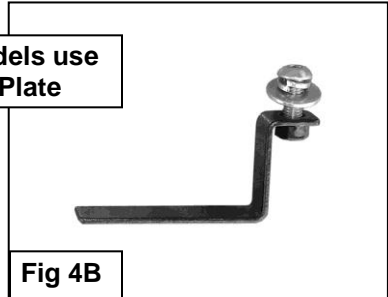

06-08 Models: (see Fig 4B-inset) Insert 8mm Nut Plate through opening behind grille and line up the threaded hole with the hole in the metal tab and grille (not pictured)

09-10 Models: (pictured) Gently pull the grille outward. Slide (1) 8mm Clip Nut onto the metal tab under the grille. Line up hole in Clip Nut with hole in metal tab and grille

**DRIVER SIDE INSTALLATION PICTURED**

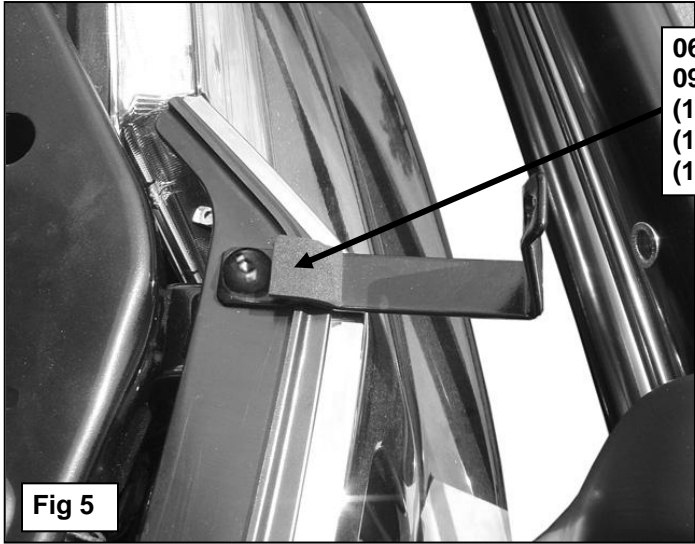

06-08 Models use (1) 8mm Nut Plate (not pictured)  
09-10 Models use (1) 8mm Clip Nut (pictured)  
(1) 8mm x 25mm Button Head Bolt  
(1) 8mm Lock Washer  
(1) 8mm Flat Washer

**Fig 5**

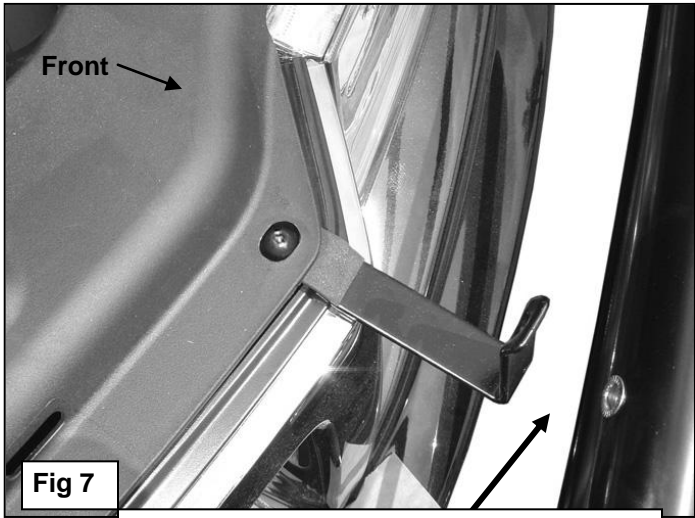

Front →

**Fig 7**

Secure Top Bracket to Grille Guard with:  
(1) 6mm x 25mm Button Head Bolt  
(1) 6mm Lock Washer  
(1) 6mm Flat Washer

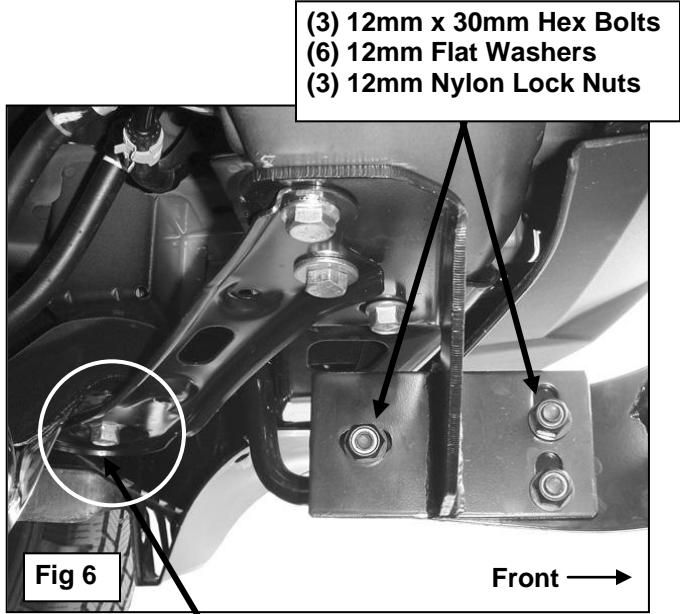

(3) 12mm x 30mm Hex Bolts  
(6) 12mm Flat Washers  
(3) 12mm Nylon Lock Nuts

**Fig 6**

Front →

**IMPORTANT: Once Grille Guard installation is complete, tighten (2) factory hex bolts in subframe mounts.**

**Driver side installation pictured**



**Complete installation**